

Planimetria stato attuale

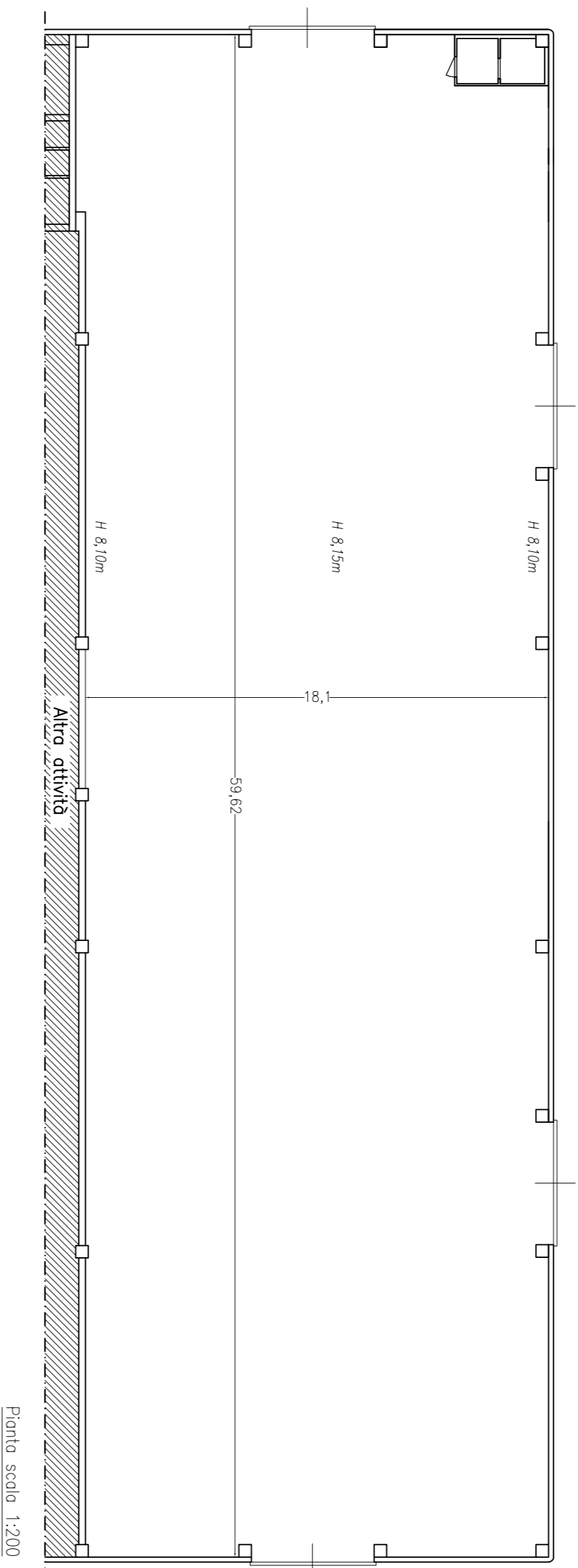

Planimetria di progetto



TAVOLA 1

Prospetto Nord-Est



Prospetto Sud-Ovest

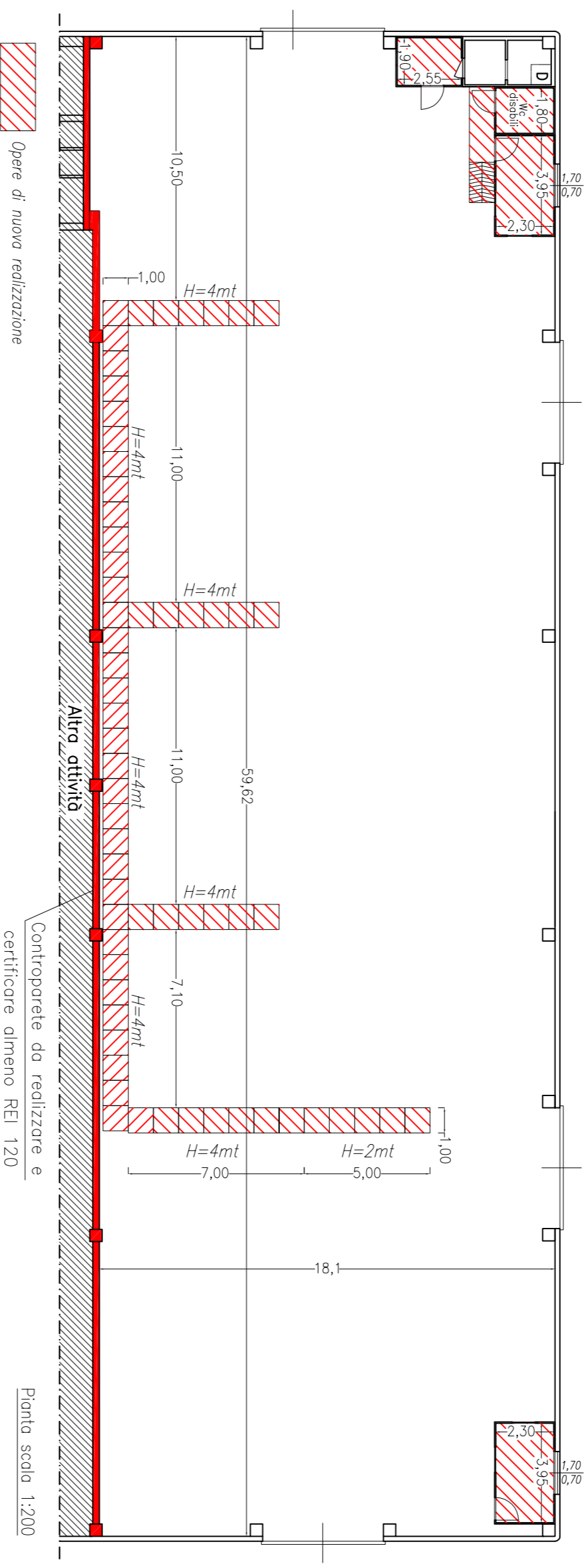
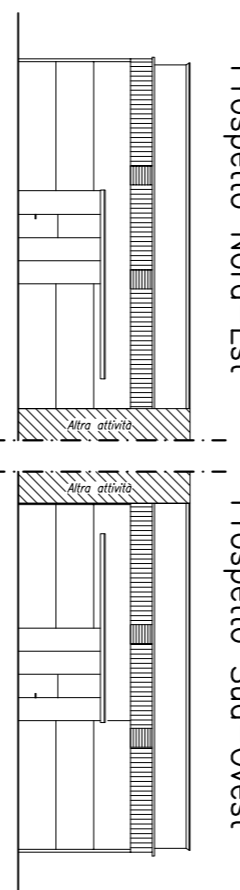
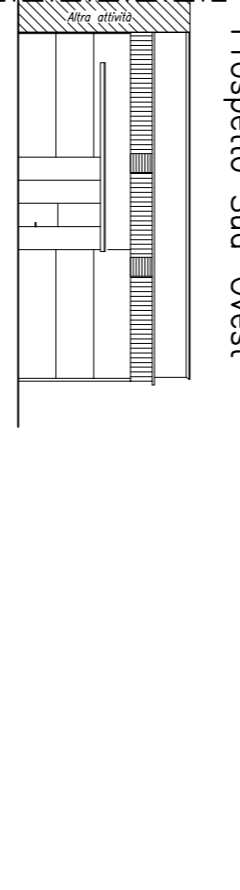

Prospetto Sud-Est

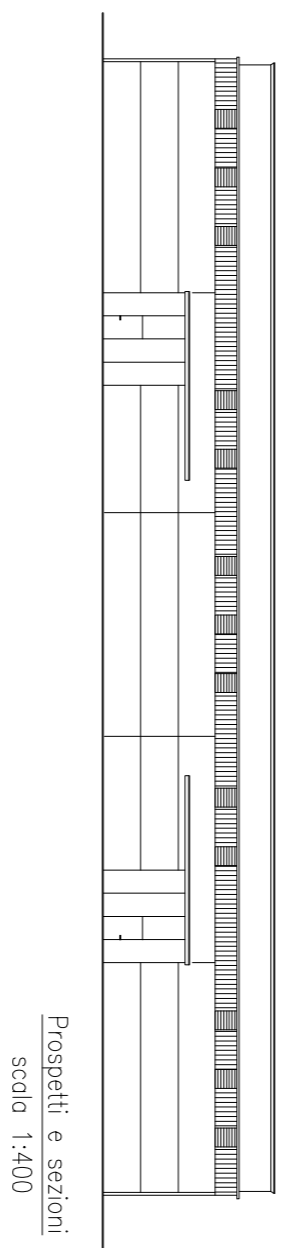

Prospetto Nord-Est

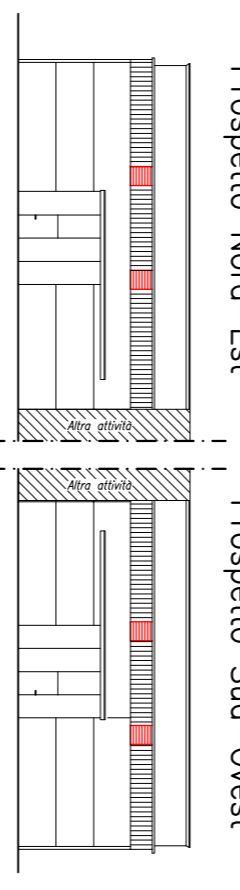

Prospetto Sud-Ovest

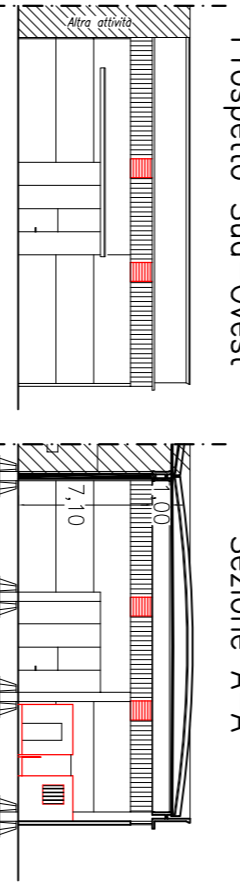

Prospetto Sud-Est

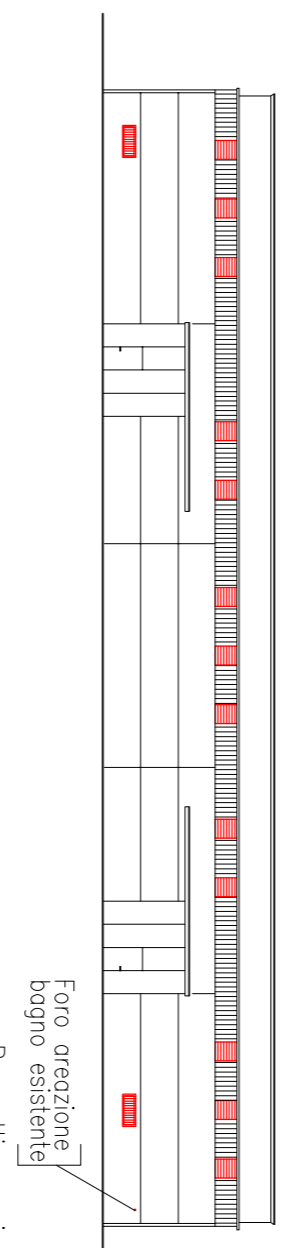

Sezione A-A'

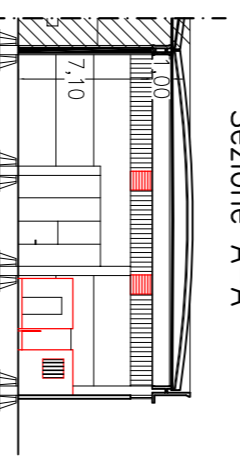

Particolare ufficio 1 e 2

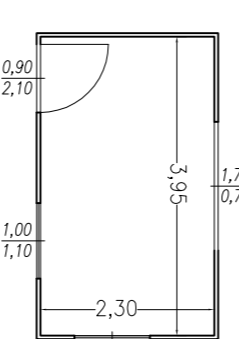

Particolare spogitocio

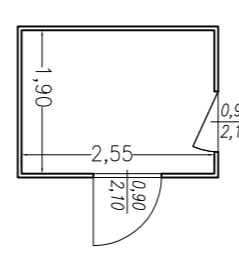

Particolare WC disabili

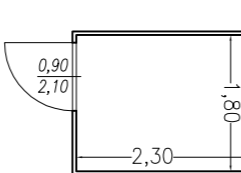

Schema bagno disabili ai sensi del D.M. 236 del 14/06/1989

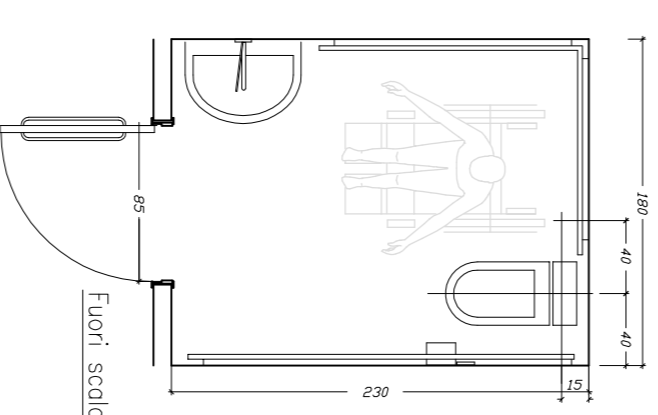

Prospetti e sezioni
scala 1:400

Foro creazione
bagno esistente
Prospetti e sezioni
scala 1:400

Legenda simboli
Apertura di creazione di blocco in posizione obliqua (simile a persiana) e retina omlinetto
Finestra di nuova realizzazione

Note:
Quote espresse in metri